

Bellows suction cups (round)

SAXB 100 ED-85 G3/8-AG

Part no...:10.01.42.00055

<https://www.schmalz.com/10.01.42.00055>

Home > Vacuum Technology for Automation > Vacuum Components > Vacuum Suction Cups > Suction Cups for Handling Sheet Metal > Bellows suction cups SAXB > SAXB 100 ED-85 G3/8-AG

High-speed bellows suction cup for adaptation to strongly curved and oiled surfaces



Size: 100

Suction cup material: Elastodur

Material hardness [Shore A]: 85 Shore A

Nipple material: Aluminum

Connection: G3/8-AG

Number of folds: 1.5

Design Data

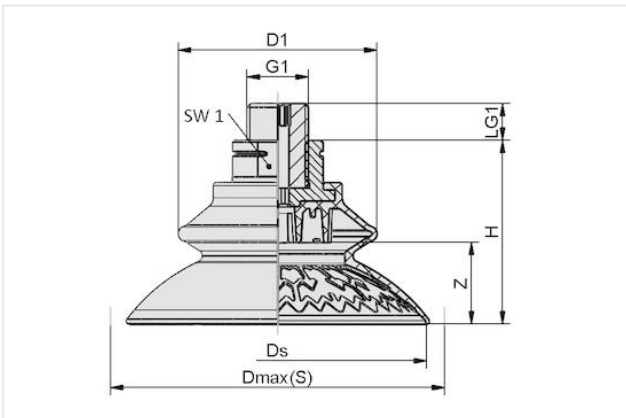

Attribute	Value
dn	6.10 mm
Dmax(S)	109 mm
Ds	99.60 mm
D1	78.40 mm
G1	G3/8"-M
H	56.60 mm
LG1	10 mm
SW1	22 mm
Z (Stroke)	25.80 mm

Technical Data

Attribute	Value
Suction force (-600mbar)	210 N
Lateral force	264 N
Lateral force (oily surface)	243 N
Volume	138.40 cm ³
Curve radius (min) (convex)	45 mm
Hose diameter (empf.) d	6 mm
Size	100
Connection	G3/8"-M

Contact Schmalz

Schmalz Sp.z.o.o. | ul. Fabianowska 131/A1, 62-052 Komorniki, Poland | +48 61 628 67 70 | schmalz@schmalz.pl



Bellows suction cups (round)

SAXB 100 ED-85 G3/8-AG

Part no...:10.01.42.00055

<https://www.schmalz.com/10.01.42.00055>

Number of folds	1.50
Suction cup material	Elastodur
Material hardness [Shore A]	85 Shore A
Weight	82.50 g
Product family	SAXB

Contact Schmalz

Schmalz Sp.z.o.o. | ul. Fabianowska 131/A1, 62-052 Komorniki, Poland | +48 61 628 67 70 | schmalz@schmalz.pl