

Bellows suction cups (round)

SAXB 40 ED-85 G1/4-IG

Part no.:10.01.42.00006

<https://www.schmalz.com/10.01.42.00006>

Home > Vacuum Technology for Automation > Vacuum Components > Vacuum Suction Cups > Suction Cups for Handling Sheet Metal > Bellows suction cups SAXB > SAXB 40 ED-85 G1/4-IG

High-speed bellows suction cup for adaptation to strongly curved and oiled surfaces



Size: 40

Suction cup material: Elastodur

Material hardness [Shore A]: 85 Shore A

Nipple material: Aluminum

Connection: G1/4-IG

Number of folds: 1.5

Design Data

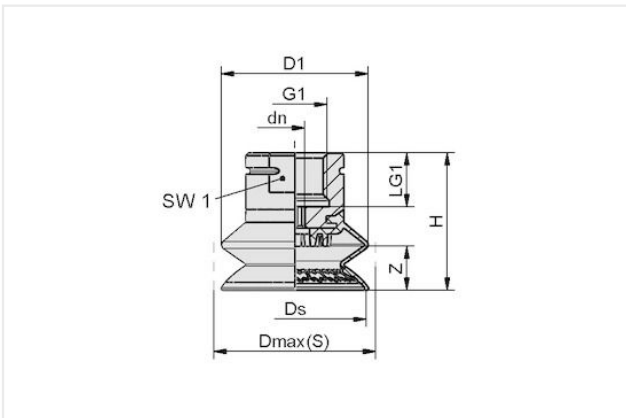

Attribute	Value
dn	4.10 mm
Dmax(S)	44 mm
Ds	39.40 mm
D1	33.80 mm
G1	G1/4"-F
H	28.80 mm
LG1	11 mm
SW1	17 mm
Z (Stroke)	9.80 mm

Technical Data

Attribute	Value
Suction force (-600mbar)	42 N
Lateral force	45 N
Lateral force (oily surface)	37 N
Volume	8.70 cm ³
Curve radius (min) (convex)	18 mm
Hose diameter (empf.) d	4 mm
Size	40
Connection	G1/4"-F

Contact Schmalz

Schmalz Sp.z.o.o. | ul. Fabianowska 131/A1, 62-052 Komorniki, Poland | +48 61 628 67 70 | schmalz@schmalz.pl



Bellows suction cups (round)

SAXB 40 ED-85 G1/4-IG

Part no...:10.01.42.00006

<https://www.schmalz.com/10.01.42.00006>

Number of folds	1.50
Suction cup material	Elastodur
Material hardness [Shore A]	85 Shore A
Weight	11.60 g
Product family	SAXB

Contact Schmalz

Schmalz Sp.z.o.o. | ul. Fabianowska 131/A1, 62-052 Komorniki, Poland | +48 61 628 67 70 | schmalz@schmalz.pl