

Bellows suction cups (round)

FSGC 50 NBR-55 G3/8-IG

Part no...:10.01.06.05659

<https://www.schmalz.com/10.01.06.05659>

Home > Vacuum Technology for Automation > Vacuum Components > Vacuum Suction Cups > Suction Cups for the Packaging Industry > Bellows Suction Cups FSGC > FSGC 50 NBR-55 G3/8-IG

Bellow suction cup (round) for logistics applications for handling a wide range of workpieces



Size: 50

Suction cup material: Nitrile rubber NBR

Material hardness [Shore A]: 55 Shore A

Nipple material: Aluminum

Vacuum connection: G3/8"-F

Number of folds: 4.5

Design Data

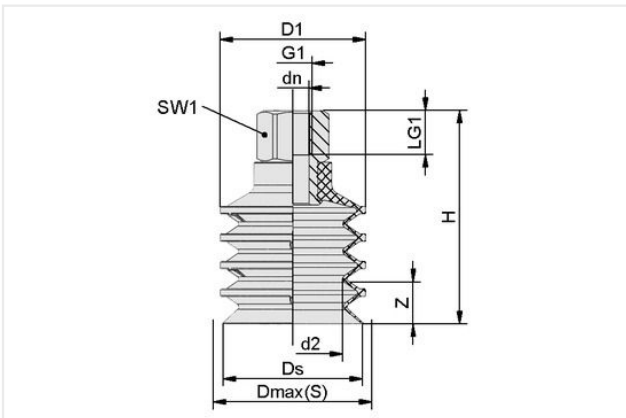

Attribute	Value
Z (Stroke)	31 mm
H	72.50 mm
Vacuum connection	G3/8"-F
D1	49.50 mm
d2	34.50 mm
Ds	47 mm
Dmax(S)	51 mm
dn	11 mm
G1	G3/8"-F
G1	G3/8-IG
LG1	12 mm
SW1	22 mm

Technical Data

Attribute	Value
Number of folds	4.50
Size	50
Suction cup material	Nitrile rubber NBR
Suction force (-600mbar)	35 N
Product family	FSGC
Material hardness [Shore A]	55 Shore A

Contact Schmalz

Schmalz Sp.z.o.o. | ul. Fabianowska 131/A1, 62-052 Komorniki, Poland | +48 61 628 67 70 | schmalz@schmalz.pl

Bellows suction cups (round)

FSGC 50 NBR-55 G3/8-IG

Part no.:10.01.06.05659

<https://www.schmalz.com/10.01.06.05659>

Nipple material	Aluminum
Pull-off force (real)	59 N
Volume	52.40 cm ³
Hose diameter (empf.) d	9 mm

Spare parts



FGC 50 NBR-55 SC080

Part no.:10.01.06.04920

Size: 50

Suction cup material: Nitrile rubber NBR

Material hardness [Shore A]: 55 Shore A

Nipple family: SC080

Number of folds: 4.5



SC 080 G3/8-IG

Part no.:10.01.06.02594

Connection geometry: 080

Vacuum connection: G3/8"-F

Length L1: 32 mm

Fitting length: 17.5 mm

Nominal diameter dn: 11 mm