

Bellows suction cups SI-HD (round)

FSGA 11 SI-HD-65 G1/8-AG

Part no.:10.01.06.04177

<https://www.schmalz.com/10.01.06.04177>

Home > Vacuum Technology for Automation > Vacuum Components > Vacuum Suction Cups > Suction Cups for the Packaging Industry > Bellows Suction Cups FSGA SI-HD (1.5 Folds) > FSGA 11 SI-HD-65 G1/8-AG

Bellows suction cup (round) with optimal adaptation to uneven surfaces



Size: 11

Suction cup material: Silicone SI-HD

Material hardness [Shore A]: 65 Shore A

Material characteristics: FDA-compatible

Nipple material: Aluminum

Connection: G1/8"-M

Number of folds: 1.5

Vacuum connection: G1/8"-M

Design Data

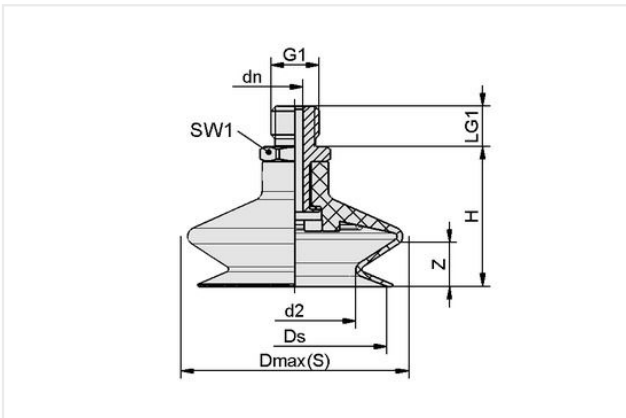

Attribute	Value
d2	5.10 mm
Dmax(S)	13 mm
dn	3.50 mm
Ds	10.40 mm
G1	G1/8"-M
H	22 mm
LG1	7.50 mm
SW1	14 mm
Z (Stroke)	4 mm

Note: Acceptable dimensional tolerances for elastomer parts concerning to DIN ISO 3302-1 M3

Technical Data

Attribute	Value
Suction cup material	Silicone SI-HD
Material hardness [Shore A]	65 Shore A
Size	11
Number of folds	1.50
Connection	G1/8-AG
Curve radius (min) (convex)	10 mm
Volume	0.23 cm ³

Contact Schmalz

Schmalz Sp.z.o.o. | ul. Fabianowska 131/A1, 62-052 Komorniki, Poland | +48 61 628 67 70 | schmalz@schmalz.pl

Bellows suction cups SI-HD (round)

FSGA 11 SI-HD-65 G1/8-AG

Part no...:10.01.06.04177

<https://www.schmalz.com/10.01.06.04177>

Suction force (-600mbar)	0.95 N
Pull-off force	3.80 N
Hose diameter (empf.) d	4 mm
Weight	4.70 g
Product family	FSGA

Note: Suction force: The specified suction forces are theoretical values at a vacuum of -0.6 bar and with a dry, smooth and flat workpiece surface - they do not include a safety factor Pull-off force: The pull-off force of the versions made of natural rubber is reduced by about 40% Hose diameter: The recommended hose diameter refers to a hose length of approx. 2 m

Accessories



SPI 11 PEEK

Part no...:10.01.06.03281

Size: 11

Material: Polyetheretherketon

Spare parts



SA-NIP N016 G1/8-AG DN350

Part no...:10.01.06.05735

Nipple family: N 016

Thread G1: G1/8"-M

Length L1: 20 mm

Fitting length: 6 mm

Nominal diameter dn: 3.5 mm

Material: Aluminum

Bellows suction cups SI-HD (round)

FSGA 11 SI-HD-65 G1/8-AG

Part no...:10.01.06.04177

<https://www.schmalz.com/10.01.06.04177>



FGA 11 SI-HD-65 N016

Part no...:10.01.06.03986

Size: 11

Suction cup material: Silicone SI-HD

Material hardness [Shore A]: 65 Shore A

Material characteristics: FDA-compatible

Number of folds: 1.5