

Bellows suction cups (round)

SPB2f 50 SI-55 G1/8-IG

Part no...:10.01.06.03653

<https://www.schmalz.com/10.01.06.03653>

Home > Vacuum Technology for Automation > Vacuum Components > Vacuum Suction Cups > Suction Cups for the Packaging Industry > Bellows Suction Cups SPB2f (2.5 Folds) > SPB2f 50 SI-55 G1/8-IG

Bellows suction cup (round) for very uneven workpieces



Size: 50

Suction cup material: Silicone SI

Material hardness [Shore A]: 55 Shore A

Thread G1: G1/8"-F

Number of folds: 2.5

Design Data

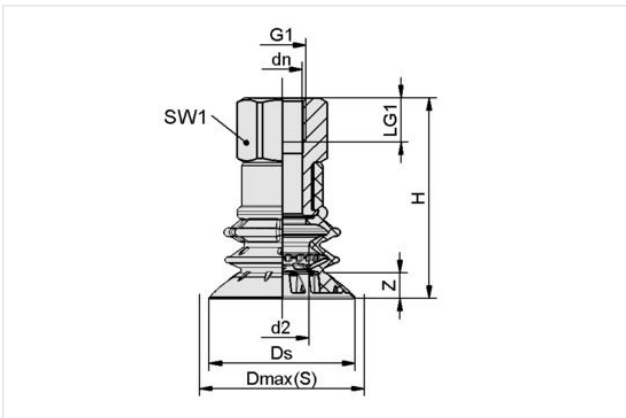

Attribute	Value
d2	21 mm
dn	8.60 mm
Dmax(S)	52 mm
Ds	49.70 mm
G1	G1/8"-F
H	67.10 mm
LG1	12 mm
SW1	27 mm
Z (Stroke)	9 mm

Technical Data

Attribute	Value
Suction force at -200 mbar	13.70 N
Suction force at -400 mbar	27.30 N
Suction force (-600mbar)	41 N
Volume	26.45 cm ³
Hose diameter (empf.) d	12 mm
Size	50
Number of folds	2.50
Suction cup material	Silicone SI

Contact Schmalz

Schmalz Sp.z.o.o. | ul. Fabianowska 131/A1, 62-052 Komorniki, Poland | +48 61 628 67 70 | schmalz@schmalz.pl

Bellows suction cups (round)

SPB2f 50 SI-55 G1/8-IG

Part no...:10.01.06.03653

<https://www.schmalz.com/10.01.06.03653>

Material hardness [Shore A]	55 Shore A
Weight	63.40 g
Product family	SPB2f

Accessories



SIEB 19.5x1 MS-A2 103

Part no...:10.07.01.00321

External diameter D: 19.5 mm

Length L: 1 mm

Material: Brass / Stainless steel

Filter pore size: 103 µm



SSB 20-32 ST-VZ

Part no...:10.07.10.00003

Clamping range: 20.0 ... 32.0 mm

Material: Steel

Surface: galvanised

Spare parts

Contact Schmalz

Schmalz Sp.z.o.o. | ul. Fabianowska 131/A1, 62-052 Komorniki, Poland | +48 61 628 67 70 | schmalz@schmalz.pl

Bellows suction cups (round)

SPB2f 50 SI-55 G1/8-IG

Part no...:10.01.06.03653

<https://www.schmalz.com/10.01.06.03653>



SC 090 G1/8-IG

Part no...:10.01.06.03272

Connection geometry: 090

Vacuum connection: G1/8"-F

Length L1: 37.5 mm

Fitting length: 21.5 mm

Nominal diameter dn: 8.6 mm



SPB2f 50 SI-55 SC090

Part no...:10.01.06.03560

Size: 50

Suction cup material: Silicone SI

Material hardness [Shore A]: 55 Shore A

Material characteristics: FDA-compatible

Number of folds: 2.5