

Bellows suction cups (round)

SPB4f 40 SI-55 G3/8-IG

Part no...:10.01.06.03549

<https://www.schmalz.com/10.01.06.03549>

Home > Vacuum Technology for Automation > Vacuum Components > Vacuum Suction Cups > Suction Cups for the Packaging Industry > Bellows Suction Cups SPB4f (4.5 Folds) > SPB4f 40 SI-55 G3/8-IG

Bellows suction cup (round) for very uneven workpieces



Size: 40
Suction cup material: Silicone SI
Material hardness [Shore A]: 55 Shore A
Thread G1: G3/8"-F
Number of folds: 4.5

Design Data

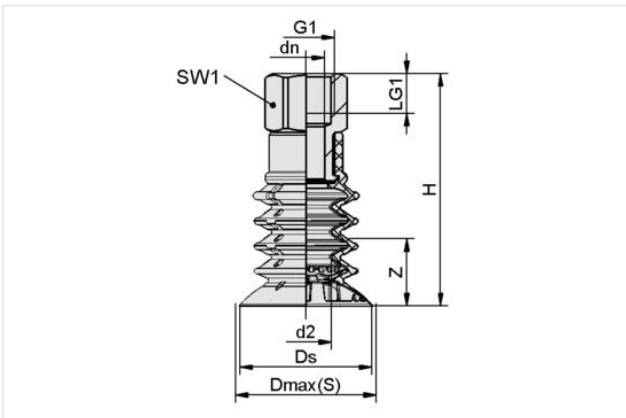

Attribute	Value
d2	15.30 mm
dn	11 mm
Dmax(S)	42 mm
Ds	39.70 mm
G1	G3/8"-F
H	69.50 mm
LG1	12 mm
SW1	22 mm
Z (Stroke)	18 mm

Technical Data

Attribute	Value
Suction force at -200 mbar	6.80 N
Suction force at -400 mbar	13.60 N
Suction force (-600mbar)	20.40 N
Pull-off force	23.80 N
Volume	15.12 cm ³
Hose diameter (empf.) d	9 mm
Number of folds	4.50
Suction cup material	Silicone SI

Contact Schmalz

Schmalz Sp.z.o.o. | ul. Fabianowska 131/A1, 62-052 Komorniki, Poland | +48 61 628 67 70 | schmalz@schmalz.pl

Bellows suction cups (round)

SPB4f 40 SI-55 G3/8-IG

Part no...:10.01.06.03549

<https://www.schmalz.com/10.01.06.03549>

Material hardness [Shore A]	55 Shore A
Weight	28.80 g
Product family	SPB4f

Accessories



SIEB 17x0.8 MS-A2 103 0.103/0.07

Part no...:10.07.01.00320

External diameter D: 17 mm

Length L: 0.8 mm

Material: Brass / Stainless steel

Filter pore size: 103 µm



SSB 16-27 ST-VZ

Part no...:10.07.10.00002

Clamping range: 16.0 ... 27.0 mm

Material: Steel

Surface: galvanised

Spare parts

Contact Schmalz

Schmalz Sp.z.o.o. | ul. Fabianowska 131/A1, 62-052 Komorniki, Poland | +48 61 628 67 70 | schmalz@schmalz.pl

Bellows suction cups (round)

SPB4f 40 SI-55 G3/8-IG

Part no...:10.01.06.03549

<https://www.schmalz.com/10.01.06.03549>



SC 080 G3/8-IG

Part no...:10.01.06.02594

Connection geometry: 080

Vacuum connection: G3/8"-F

Length L1: 32 mm

Fitting length: 17.5 mm

Nominal diameter dn: 11 mm



SPB4f 40 SI-55 SC080

Part no...:10.01.06.03265

Size: 40

Suction cup material: Silicone SI

Material hardness [Shore A]: 55 Shore A

Number of folds: 4.5