

Bellows suction cup (round)

SPB4f 30 SI-55 SC080

Part no...:10.01.06.03264

<https://www.schmalz.com/10.01.06.03264>

Home > Vacuum Technology for Automation > Vacuum Components > Vacuum Suction Cups > Suction Cups for the Packaging Industry > SPB4f 30 SI-55 SC080

Bellows suction cup (round) for very uneven workpieces



Size: 30

Suction cup material: Silicone SI

Material hardness [Shore A]: 55 Shore A

Number of folds: 4.5

Design Data

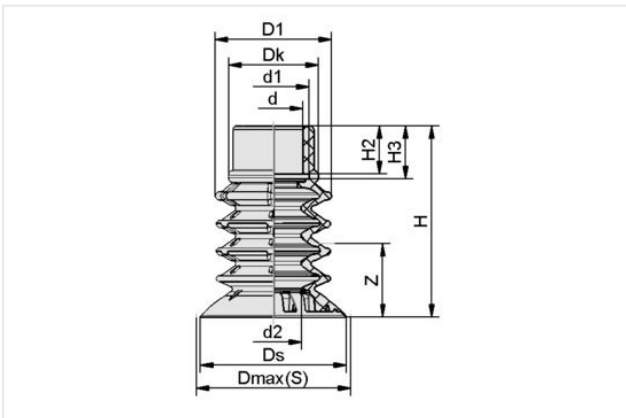

Attribute	Value
d	16 mm
d1	19.60 mm
d2	12.30 mm
D1	22.40 mm
Dk	24.40 mm
Dmax(S)	32 mm
Ds	30.70 mm
H	40 mm
H2	13 mm
H3	14.40 mm
Z (Stroke)	11 mm

Technical Data

Attribute	Value
Suction force at -200 mbar	4.30 N
Suction force at -400 mbar	8.50 N
Suction force (-600mbar)	12.80 N
Volume	5.99 cm ³
Size	30
Nipple family	SC 080

Contact Schmalz

Schmalz Sp.z.o.o. | ul. Fabianowska 131/A1, 62-052 Komorniki, Poland | +48 61 628 67 70 | schmalz@schmalz.pl

Bellows suction cup (round)

SPB4f 30 SI-55 SC080

Part no...:10.01.06.03264

<https://www.schmalz.com/10.01.06.03264>

Number of folds	4.50
Suction cup material	Silicone SI
Material hardness [Shore A]	55 Shore A
Weight	6.20 g
Product family	SPB4f

Accessories



SC 080 NPT1/4-AG

Part no...:10.01.06.03662

Connection geometry: 080

Vacuum connection: NPT1/4-M

Length L1: 32.2 mm

Fitting length: 7.5 mm

Nominal diameter dn: 8 mm



SC 080 NPT1/4-IG

Part no...:10.01.06.03663

Connection geometry: 080

Vacuum connection: NPT1/4-F

Length L1: 32 mm

Fitting length: 17.5 mm

Nominal diameter dn: 10.3 mm

Bellows suction cup (round)

SPB4f 30 SI-55 SC080

Part no...:10.01.06.03264

<https://www.schmalz.com/10.01.06.03264>



SC 080 NPT3/8-AG

Part no...:10.01.06.03664

Connection geometry: 080

Vacuum connection: NPT3/8-M

Length L1: 32.4 mm

Fitting length: 7.5 mm

Nominal diameter dn: 10.3 mm



SC 080 NPT3/8-IG

Part no...:10.01.06.03665

Connection geometry: 080

Vacuum connection: NPT3/8-F

Length L1: 32 mm

Fitting length: 17.5 mm

Nominal diameter dn: 10.3 mm



SIEB 17x0.8 MS-A2 103 0.103/0.07

Part no...:10.07.01.00320

External diameter D: 17 mm

Length L: 0.8 mm

Material: Brass / Stainless steel

Filter pore size: 103 µm