

Bellows suction cup (round)

SPB2 40 SI-55 SW150 P

Part no...:10.01.06.03227

<https://www.schmalz.com/10.01.06.03227>

Home > Vacuum Technology for Automation > Vacuum Components > Vacuum Suction Cups > Suction Cups for the Packaging Industry > Bellows Suction Cups SPB2 P (2.5 Folds) Flow Restrictor > SPB2 40 SI-55 SW150 P

Bellows suction cup (round) with 2.5 corr. for dynamic handling of cardboard and rigid packaging



Size: 40

Suction cup material: Silicone SI

Material hardness [Shore A]: 55 Shore A

Height H: 47 mm

Design Data

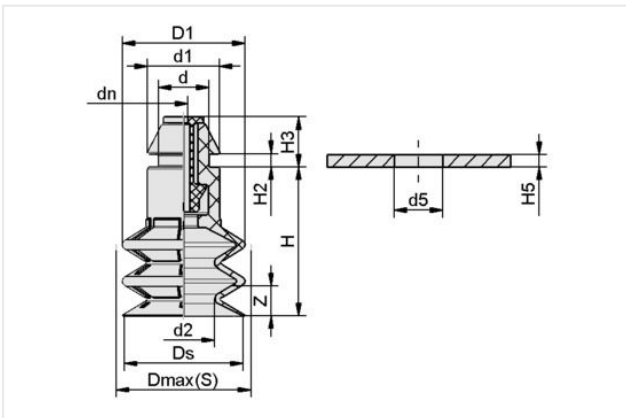

Attribute	Value
d	12.50 mm
d1	15.70 mm
d2	17.80 mm
d5	11.50 mm
dn	1.50 mm
D1	43.50 mm
Dmax(S)	44.60 mm
Ds	42.70 mm
H	47 mm
H2	2.20 mm
H3	8.20 mm
H5	2 mm
Z (Stroke)	20 mm

Technical Data

Attribute	Value
Suction force (-600mbar)	14.90 N
Pull-off force	40 N
Volume	22 cm ³
Curve radius (min) (convex)	75 mm

Contact Schmalz

Schmalz Sp.z.o.o. | ul. Fabianowska 131/A1, 62-052 Komorniki, Poland | +48 61 628 67 70 | schmalz@schmalz.pl

Bellows suction cup (round)

SPB2 40 SI-55 SW150 P

Part no...:10.01.06.03227

<https://www.schmalz.com/10.01.06.03227>

Size	40
Number of folds	2.50
Suction cup material	Silicone SI
Material hardness [Shore A]	55 Shore A
Weight	18.50 g
Product family	SPB2

Accessories



FD 34 120

Part no...:10.01.06.02572

External diameter D: 34 mm

Filter pore size: 120 µm

Construction use: Bellows suction cup

Size: FG 42

Spare parts



SW 150 P 7.3

Part no...:10.05.04.00093

Shape: Push In

Length L: 15.5 mm

Material: Polyoxymethylene

External diameter D: 7.3 mm

Bellows suction cup (round)

SPB2 40 SI-55 SW150 P

Part no...:10.01.06.03227

<https://www.schmalz.com/10.01.06.03227>



SPB2 40 SI-55 P

Part no...:10.01.06.03126

Size: 40

Suction cup material: Silicone SI

Material hardness [Shore A]: 55 Shore A

Number of folds: 2.5

Shape: Push In