

Bellows suction cup (round)

SPB2 20 SI-40 SW80 P

Part no...:10.01.06.03220

<https://www.schmalz.com/10.01.06.03220>

Home > Vacuum Technology for Automation > Vacuum Components > Vacuum Suction Cups > Suction Cups for the Packaging Industry > Bellows Suction Cups SPB2 P (2.5 Folds) Flow Restrictor > SPB2 20 SI-40 SW80 P

Bellows suction cup (round) with 2.5 corr. for dynamic handling of cardboard and rigid packaging



Size: 20

Suction cup material: Silicone SI

Material hardness [Shore A]: 40 Shore A

Height H: 24.3 mm

Design Data

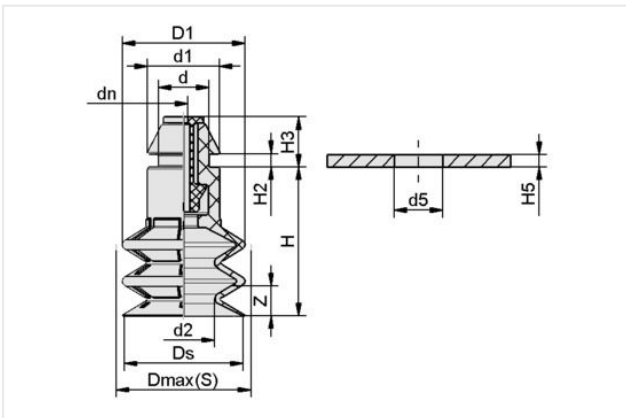

Attribute	Value
d	8.50 mm
d1	11.80 mm
d2	10.20 mm
d5	7.90 mm
dn	0.80 mm
D1	20 mm
Dmax(S)	20.50 mm
Ds	19.60 mm
H	24.30 mm
H2	2.20 mm
H3	8.20 mm
H5	2 mm
Z (Stroke)	9 mm

Technical Data

Attribute	Value
Suction force (-600mbar)	4.90 N
Pull-off force	8 N
Volume	2.50 cm ³
Curve radius (min) (convex)	25 mm

Contact Schmalz

Schmalz Sp.z.o.o. | ul. Fabianowska 131/A1, 62-052 Komorniki, Poland | +48 61 628 67 70 | schmalz@schmalz.pl

Bellows suction cup (round)

SPB2 20 SI-40 SW80 P

Part no...:10.01.06.03220

<https://www.schmalz.com/10.01.06.03220>

Size	20
Number of folds	2.50
Suction cup material	Silicone SI
Material hardness [Shore A]	40 Shore A
Weight	2.50 g
Product family	SPB2

Accessories



FD 16 120

Part no...:10.01.06.02565

External diameter D: 16 mm

Filter pore size: 120 µm

Construction use: Bellows suction cup

Size: FG20/FGA20

Spare parts



SW 80 P 7.3

Part no...:10.05.04.00090

Shape: Push In

Length L: 15.5 mm

Material: Polyoxymethylene

External diameter D: 7.3 mm

Bellows suction cup (round)

SPB2 20 SI-40 SW80 P

Part no...:10.01.06.03220

<https://www.schmalz.com/10.01.06.03220>



SPB2 20 SI-40 P

Part no...:10.01.06.03125

Size: 20

Suction cup material: Silicone SI

Material hardness [Shore A]: 40 Shore A

Number of folds: 2.5

Shape: Push In