

Bellows suction cup HT1 (round)

SAB 50 HT1-60 G3/8-AG

Part no...:10.01.06.03058

<https://www.schmalz.com/10.01.06.03058>

Home > Vacuum Technology for Automation > Vacuum Components > Vacuum Suction Cups > Suction Cups for Handling Glass > Bellows Suction Cups SAB HT1 (1.5 Folds) > SAB 50 HT1-60 G3/8-AG

Bellows suction cup (round) for markless handling of workpieces



Size: 50

Suction cup material: High temp material HT1

Material hardness [Shore A]: 60 Shore A

Nipple material: Aluminum

Connection: G3/8-AG

Number of folds: 1.5

Design Data

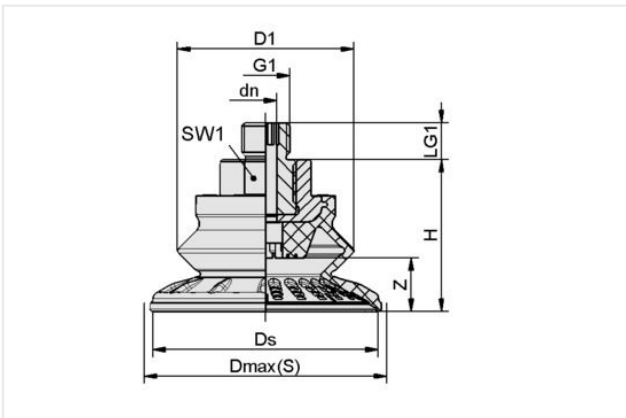

Attribute	Value
dn	6 mm
D1	39.50 mm
Dmax(S)	56 mm
Ds	50.10 mm
G1	G3/8"-M
H	36.90 mm
LG1	10 mm
SW1	22 mm
Z (Stroke)	11.50 mm

Technical Data

Attribute	Value
Suction force (-600mbar)	53 N
Pull-off force	87 N
Lateral force	55 N
Lateral force (oily surface)	52 N
Volume	11.50 cm ³
Curve radius (min) (convex)	50 mm
Hose diameter (empf.) d	4 mm
Size	50

Contact Schmalz

Schmalz Sp.z.o.o. | ul. Fabianowska 131/A1, 62-052 Komorniki, Poland | +48 61 628 67 70 | schmalz@schmalz.pl



Bellows suction cup HT1 (round)

SAB 50 HT1-60 G3/8-AG

Part no...:10.01.06.03058

<https://www.schmalz.com/10.01.06.03058>

Number of folds	1.50
Suction cup material	High temp material HT1
Material hardness [Shore A]	60 Shore A
Weight	43.20 g
Product family	SAB

Contact Schmalz

Schmalz Sp.z.o.o. | ul. Fabianowska 131/A1, 62-052 Komorniki, Poland | +48 61 628 67 70 | schmalz@schmalz.pl