

Flat suction cup (round)

SUF 3 NBR-55 SC010

Part no...:10.01.01.14285

<https://www.schmalz.com/10.01.01.14285>

Home > Vacuum Technology for Automation > Vacuum Components > Vacuum Suction Cups > Flat Suction Cups (Round) > SUF 3 NBR-55 SC010

Flat suction cup (round) f. process- safe handling of smooth or slightly rough surfaces



Size: 3

Suction cup material: Nitrile rubber NBR

Material hardness [Shore A]: 55 Shore A

Design Data

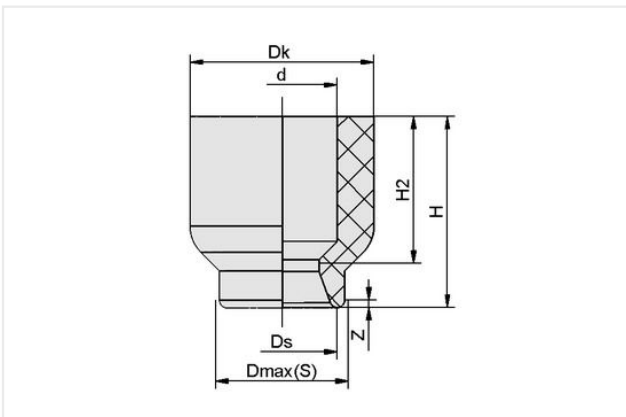

Attribute	Value
d	1.40 mm
Dk	4.20 mm
Dmax(S)	3.70 mm
Ds	3 mm
H	3.50 mm
H2	2 mm
Z (Stroke)	0.30 mm

Technical Data

Attribute	Value
Suction force (-600mbar)	0.30 N
Pull-off force	0.30 N
Volume	0.00 cm ³
Curve radius (min) (convex)	8 mm
Size	3
Nipple family	SC010
Suction cup material	Nitrile rubber NBR
Material hardness [Shore A]	55 Shore A
Weight	0 g

Contact Schmalz

Schmalz Sp.z.o.o. | ul. Fabianowska 131/A1, 62-052 Komorniki, Poland | +48 61 628 67 70 | schmalz@schmalz.pl

Flat suction cup (round)

SUF 3 NBR-55 SC010

Part no.:10.01.01.14285

<https://www.schmalz.com/10.01.01.14285>

Product family

SUF

Accessories



SC 010 M3-AG

Part no.:10.01.06.04249

Connection geometry: 010

Vacuum connection: M3-M

Fitting length: 2 mm

Nominal diameter dn: 1 mm