

## Flat suction pad (round)

SUF 2 SI-55 M3-AG

Part no...:10.01.01.14204

<https://www.schmalz.com/10.01.01.14204>

Home > Vacuum Technology for Automation > Vacuum Components > Vacuum Suction Cups > Suction Cups for the Electronics Industry > Flat Suction Cups SUF > SUF 2 SI-55 M3-AG

### Flat suction cup (round) for process safe handling of smooth or slightly rough surfaces



Size: 2

Suction cup material: Silicone SI

Material hardness [Shore A]: 55 Shore A

Material characteristics: FDA-compatible

Vacuum connection: M3-M

### Design Data

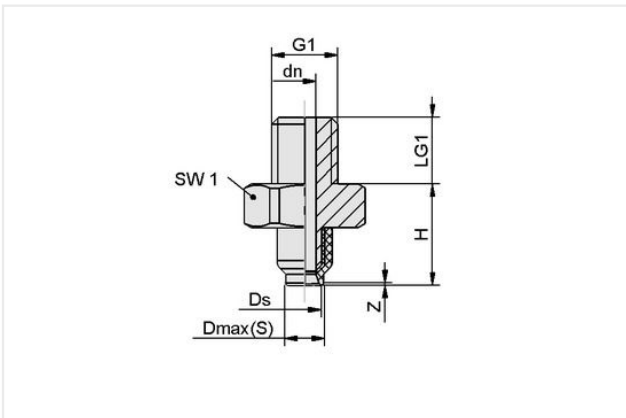

Attribute	Value
Dmax(S)	2.40 mm
Ds	2 mm
dn	1 mm
G1	M3-M
H	5.50 mm
LG1	3 mm
SW1	5 mm
Z (Stroke)	0.20 mm

### Technical Data

Attribute	Value
Suction force (-600mbar)	0.15 N
Pull-off force	0.15 N
Volume	0.00 cm <sup>3</sup>
Curve radius (min) (convex)	2 mm
Hose diameter (empf.) d	2 mm
Size	2
Suction cup material	Silicone SI
Material hardness [Shore A]	55 Shore A

### Contact Schmalz

Schmalz Sp.z.o.o. | ul. Fabianowska 131/A1, 62-052 Komorniki, Poland | +48 61 628 67 70 | [schmalz@schmalz.pl](mailto:schmalz@schmalz.pl)

## Flat suction pad (round)

SUF 2 SI-55 M3-AG

Part no...:10.01.01.14204

<https://www.schmalz.com/10.01.01.14204>

Weight	0.20 g
Product family	SUF
Number of folds	0

Note: Suction force: The specified suction forces are theoretical values at a vacuum of -0.6 bar and with a dry, smooth and flat workpiece surface - they do not include a safety factor  
Hose diameter: The recommended hose diameter refers to a hose length of approx. 2 m

### Spare parts



#### SC 010 M3-AG

Part no...:10.01.06.04249

Connection geometry: 010

Vacuum connection: M3-M

Fitting length: 2 mm

Nominal diameter dn: 1 mm



#### SUF 2 SI-55 SC010

Part no...:10.01.01.13960

Size: 2

Suction cup material: Silicone SI

Material characteristics: FDA-compatible

Material hardness [Shore A]: 55 Shore A