

Flat suction pad (round)

SUF 4 NBR-55 M3-AG

Part no.:10.01.01.14201

<https://www.schmalz.com/10.01.01.14201>

Home > Vacuum Technology for Automation > Vacuum Components > Vacuum Suction Cups > Suction Cups for the Electronics Industry > Flat Suction Cups SUF > SUF 4 NBR-55 M3-AG

Flat suction cup (round) for process safe handling of smooth or slightly rough surfaces



Size: 4

Suction cup material: Nitrile rubber NBR

Material hardness [Shore A]: 55 Shore A

Vacuum connection: M3-M

Design Data

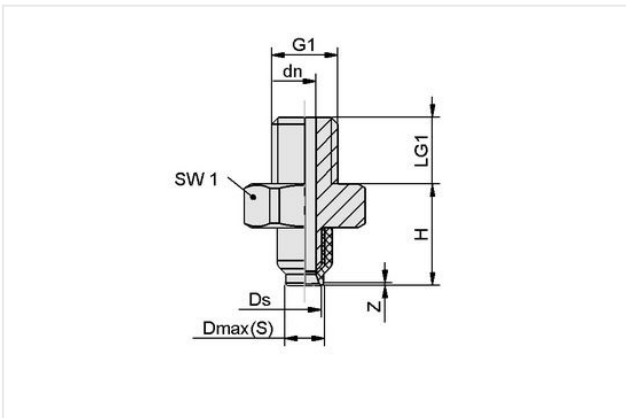

Attribute	Value
Dmax(S)	4.70 mm
Ds	4 mm
dn	1 mm
G1	M3-M
H	5.50 mm
LG1	3 mm
SW1	5 mm
Z (Stroke)	0.40 mm

Technical Data

Attribute	Value
Suction force (-600mbar)	0.40 N
Pull-off force	0.40 N
Volume	0.01 cm ³
Curve radius (min) (convex)	8 mm
Hose diameter (empf.) d	2 mm
Size	4
Suction cup material	Nitrile rubber NBR
Material hardness [Shore A]	55 Shore A

Contact Schmalz

Schmalz Sp.z.o.o. | ul. Fabianowska 131/A1, 62-052 Komorniki, Poland | +48 61 628 67 70 | schmalz@schmalz.pl

Flat suction pad (round)

SUF 4 NBR-55 M3-AG

Part no...:10.01.01.14201

<https://www.schmalz.com/10.01.01.14201>

Weight	0.20 g
Product family	SUF
Number of folds	0

Note: Suction force: The specified suction forces are theoretical values at a vacuum of -0.6 bar and with a dry, smooth and flat workpiece surface - they do not include a safety factor
Hose diameter: The recommended hose diameter refers to a hose length of approx. 2 m

Spare parts



SC 010 M3-AG

Part no...:10.01.06.04249

Connection geometry: 010

Vacuum connection: M3-M

Fitting length: 2 mm

Nominal diameter dn: 1 mm



SUF 4 NBR-55 SC010

Part no...:10.01.01.13939

Size: 4

Suction cup material: Nitrile rubber NBR

Material hardness [Shore A]: 55 Shore A