

## Flat suction cup (round)

SUF 8 HT1-60 SC020

Part no...:10.01.01.13986

<https://www.schmalz.com/10.01.01.13986>

Home > Vacuum Technology for Automation > Vacuum Components > Vacuum Suction Cups > Flat Suction Cups (Round) > SUF 8 HT1-60 SC020

### Flat suction cup (round) f. process- safe handling of smooth or slightly rough surfaces

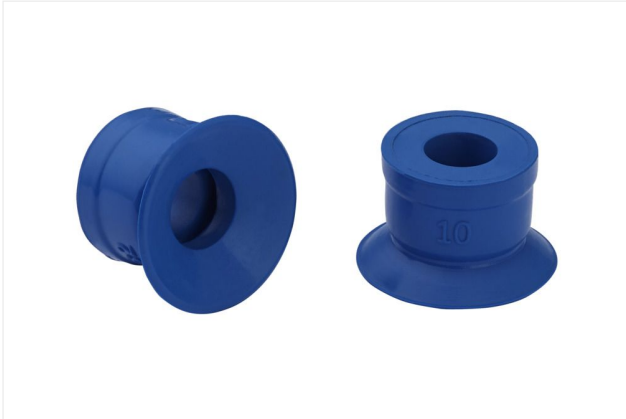

Size: 8

Suction cup material: High temp material HT1

Material hardness [Shore A]: 60 Shore A

### Design Data

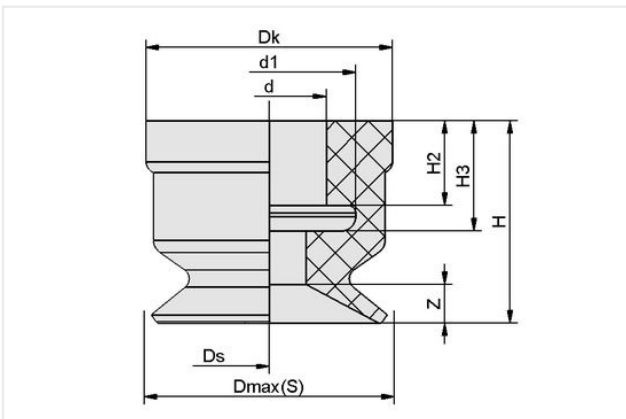

Attribute	Value
d1	4.70 mm
d	3.10 mm
Dk	6.70 mm
Dmax(S)	8.40 mm
Ds	8 mm
H	5.50 mm
H2	2.30 mm
H3	3 mm
Z (Stroke)	0.80 mm

### Technical Data

Attribute	Value
Suction force (-600mbar)	2.40 N
Pull-off force	2.40 N
Volume	0.04 cm <sup>3</sup>
Curve radius (min) (convex)	8 mm
Size	8
Nipple family	SC020
Suction cup material	High temp material HT1
Material hardness [Shore A]	60 Shore A
Weight	0.20 g

### Contact Schmalz

Schmalz Sp.z.o.o. | ul. Fabianowska 131/A1, 62-052 Komorniki, Poland | +48 61 628 67 70 | [schmalz@schmalz.pl](mailto:schmalz@schmalz.pl)

## Flat suction cup (round)

SUF 8 HT1-60 SC020

Part no...:10.01.01.13986

<https://www.schmalz.com/10.01.01.13986>

Product family

SUF

### Accessories



#### SC 020 M5-AG

Part no...:10.01.06.04273

Connection geometry: 020

Vacuum connection: M5-M

Fitting length: 5 mm

Nominal diameter dn: 1.8 mm



#### SC 020 M5-IG

Part no...:10.01.06.04306

Connection geometry: 020

Vacuum connection: M5-F

Fitting length: 8.7 mm

Nominal diameter dn: 1.8 mm