

Flat suction cup (round)

SHFN 50 NK-45 G1/4-AG MOS-TV

Part no...:10.01.01.11700

<https://www.schmalz.com/10.01.01.11700>

Home > Vacuum Technology for Automation > Vacuum Components > Vacuum Suction Cups > Suction Cups for Handling Wood > Flat Suction Cups
SHFN > SHFN 50 NK-45 G1/4-AG MOS-TV

Flat suction cup (round) for highly dynamic handling of wood



Size: 50

Suction cup material: Natural Rubber NK

Material hardness [Shore A]: 45 Shore A

Nipple material: Aluminum

Connection: G1/4-AG

Design Data

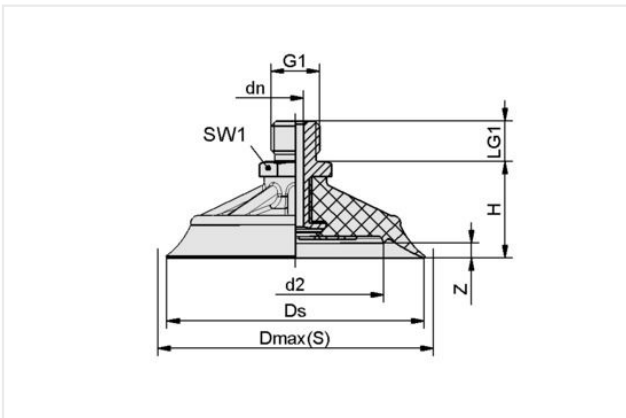

Attribute	Value
d2	21 mm
dn	4.40 mm
Dmax(S)	55 mm
Ds	52 mm
G1	G1/4"-M
H	32.20 mm
LG1	11 mm
SW1	17 mm
Z (Stroke)	3 mm

Note: Acceptable dimensional tolerances for elastomer parts concerning to DIN ISO 3302-1 M3

Technical Data

Attribute	Value
Size	50
Suction cup material	Natural Rubber NK
Suction force d2	40 N
Suction force (-600mbar)	110 N
Lateral force	95 N
Volume	6.30 cm ³
Curve radius (min) (convex)	41 mm

Contact Schmalz

Schmalz Sp.z.o.o. | ul. Fabianowska 131/A1, 62-052 Komorniki, Poland | +48 61 628 67 70 | schmalz@schmalz.pl

Flat suction cup (round)

SHFN 50 NK-45 G1/4-AG MOS-TV

Part no...:10.01.01.11700

<https://www.schmalz.com/10.01.01.11700>

Hose diameter (empf.) d	4 mm
Number of folds	0
Weight	19.10 g
Product family	SHFN

Note: Suction force: The specified suction forces are theoretical values at a vacuum of -0.6 bar and with a dry, smooth and flat workpiece surface - they do not include a safety factor Pull-off force: The pull-off force of the versions made of natural rubber is reduced by about 40% Hose diameter: The recommended hose diameter refers to a hose length of approx. 2 m

Accessories



SIEB 15x0.8 MS-A2 0.103/0.07

Part no...:10.07.01.00211

External diameter D: 15 mm

Length L: 0.8 mm

Material: Brass / Stainless steel

Spare parts



TVN G1/4-AG 8.4 N041

Part no...:10.05.10.00058

Thread G1: G1/4"-M

Spring stroke Z: 8.4 mm

Nipple: N 041

Flat suction cup (round)

SHFN 50 NK-45 G1/4-AG MOS-TV

Part no...:10.01.01.11700

<https://www.schmalz.com/10.01.01.11700>



SHF 50 NK-45 N041 MOS

Part no...:10.01.01.11688

Size: 50

Suction cup material: Natural Rubber NK

Material hardness [Shore A]: 45 Shore A