

A-A (1:1)

EXAMPLE OF ACCESSORY  
(not included in kit)

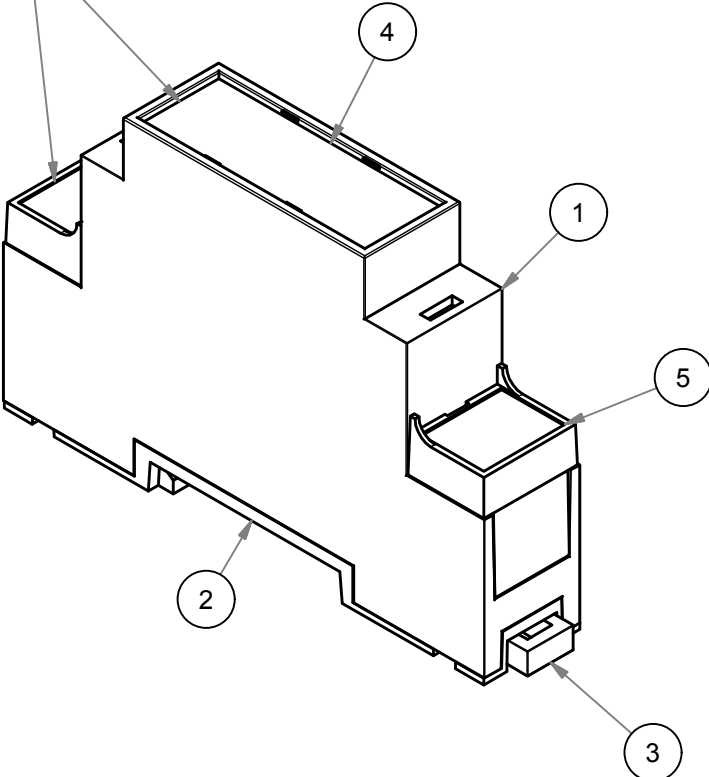

RIF.	MATERIAL	COLOR STD	KIT
1	PPO UL94V-0	GRAY	INCLUDED
2	PPO UL94V-0	GRAY	INCLUDED
3	PPO UL94V-0	BLACK	INCLUDED
4	PPO UL94V-0	GRAY	NOT INCLUDED
5	PPO UL94V-0	GRAY	NOT INCLUDED

B-B (1:1)

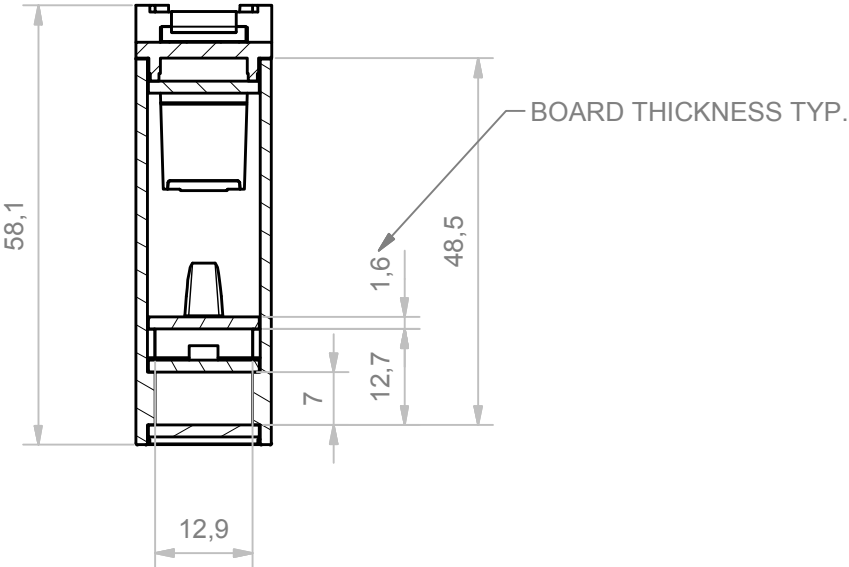

BOARD THICKNESS TYP.

COMPONENTS LIST						
RIF.	Q.TY	DESCRIPTION		CODE		
1	1	CORPO CONTENITORE 1MH53 - BODY ENCLOSURE 1MH53		M-00191		
2	1	BASE PER CONTENITORE 1M - BASE FOR ENCLOSURE 1M		M-00428		
3	1	AGGANCIAMENTO 1 MODULO - HOOK 1 MODUL		M-00427		
4	1	PANNELLO 1M - PANEL 1M		M-00994		
5	2	COPRIMORSETTO 1MPN - TERMINAL COVER 1MPN		M-00024		
		Da 0,5 a 3	Oltre 3 fino a 6	Oltre 6 fino a 30	Oltre 30 fino a 120	Oltre 120
		± 0,1	± 0,1	± 0,2	± 0,3	± 0,5

<b>RESERVED PROPERTY</b> The present drawing cannot be reproduced or communicated to 3d parties, even partially, without the authorization of ITALTRONIC Srl. Italtronic reserves to protect its own rights according to the law.	Dimension in mm	SHEET NR. 1 / 2	DRAWING BY Manual modification are not allowed	GENERAL TOLERANCE <b>UNI EN 22768/1</b> <b>Media (m)</b>	5 4 3 2 1
		Date: 21/11/2014	Replace nr.	Revision description	

 UN PARTNER PER IL FUTURO	Denomination: Contenitore completo Modulbox 1MH53
	Complete enclosure Modulbox 1MH53
 eternovica	Drawing nr. <b>M-05727-00</b>

Vedere nel catalogo tutti gli accessori compatibili con il kit.  
See in the catalog all the accessories compatible with the kit.

TOLERANCE GENERAL PCB ±0.1 mm

PCB THICKNESS 1.6 mm

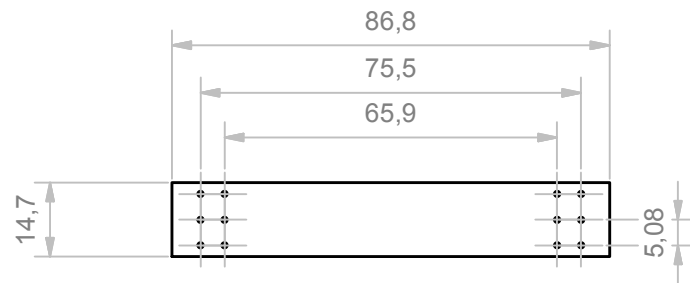

CIRCUIT BOARD "A"  
(NOT SUPPLIED)

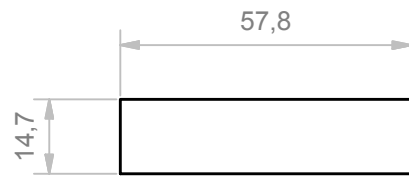

CIRCUIT BOARD "B"  
(NOT SUPPLIED)

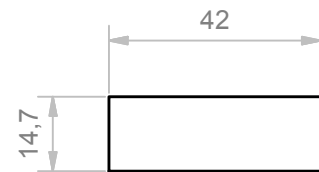

CIRCUIT BOARD "C"  
(NOT SUPPLIED)

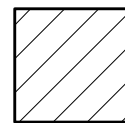

ZONE NO COMPONENTS

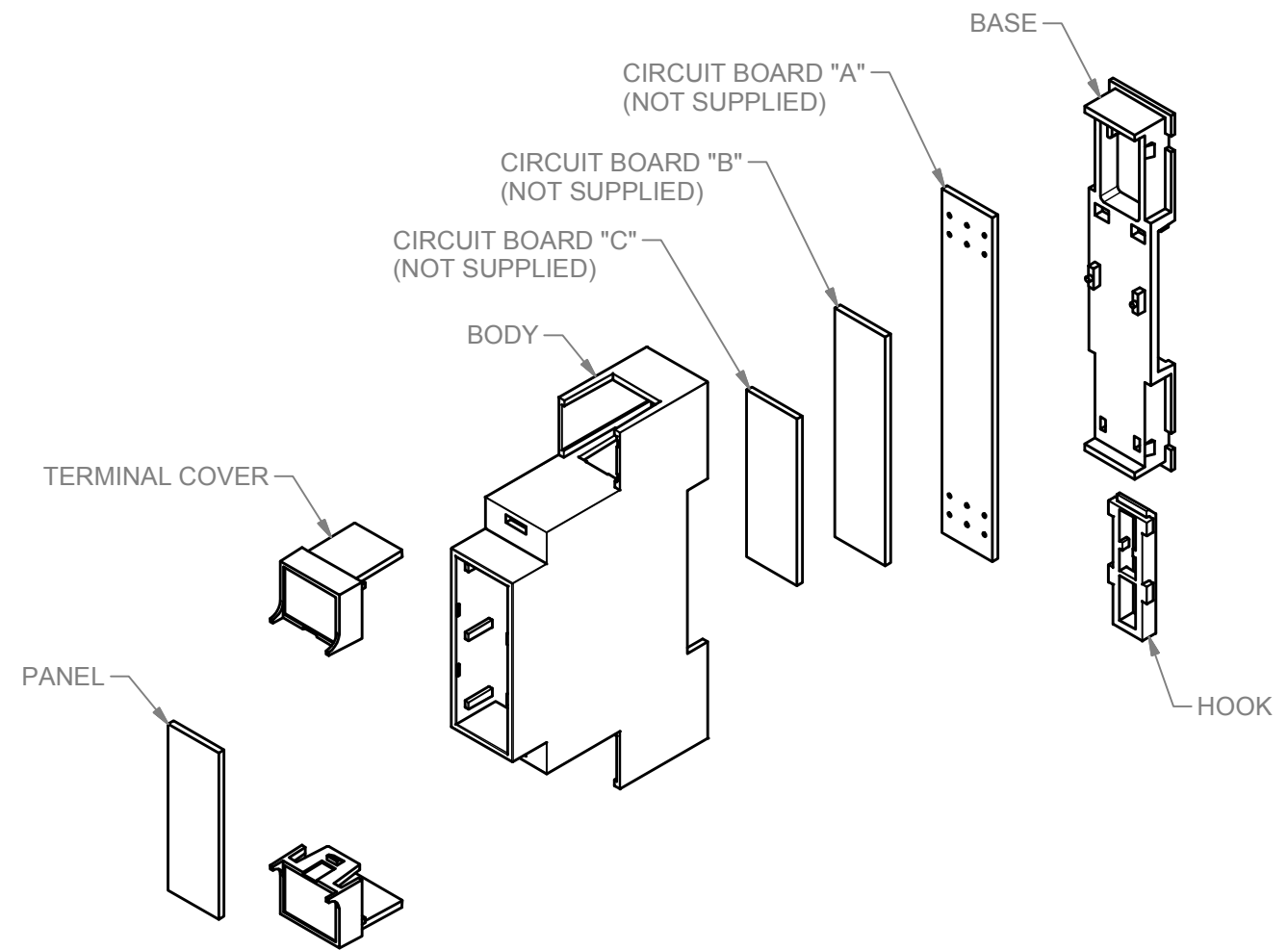

SEE LINK FOR TECHNICAL PCB  
<http://www.italtronic.info/download/modulboxone/PCB/>

Da 0,5 a 3	Oltre 3 fino a 6	Oltre 6 fino a 30	Oltre 30 fino a 120	Oltre 120
± 0,1	± 0,1	± 0,2	± 0,3	± 0,5

**RESERVED PROPERTY**

The present drawing cannot be reproduced or communicated to 3d parties, even partially, without the authorization of ITALTRONIC Srl. Italtronic reserves to protect its own rights according to the law.

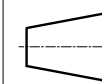

Dimension in mm

SHEET NR.  
2 / 2

DRAWING BY  
**GAD**  
Manual modification are not allowed

GENERAL TOLERANCE  
**UNI EN 22768/1**  
**Media (m)**

5 4 3 2 1

Date: 21/11/2014

Replace nr.

Revision description

Drawed: Rigato N.

Checked: Dalla Montà D.

Scale: 1:1



Denomination:

Contenitore completo Modulbox 1MH53

Complete enclosure Modulbox 1MH53

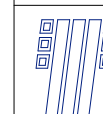

**ITALTRONIC** S.R.L.  
VIA AUSTRIA 25/D 35127  
PADOVA - ITALY  
[www.italtronic.com](http://www.italtronic.com)

Drawing nr.

**M-05727-00**