

# INSTALLATION BOXES SURFACE-MOUNTED EP-LUX TYPE PK

IP 55 650 °C 400 V PP

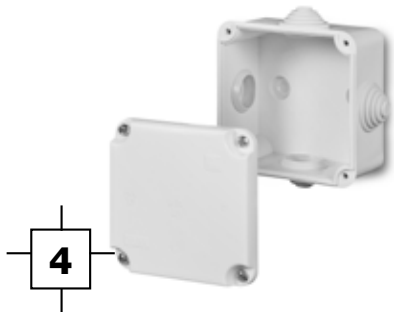

## BOX N/T HERMETIC PK-0 EP-LUX IP 55

Type	Colour	Pack. pcs.	Weight Pack./Kgs	Index
PK-0	White RAL 9003	20	10,53	<b>0224-00</b>
	Grey RAL 7035*	20	10,53	<b>0224-04</b>

NORM: PN-IEC-60998-1:2006.  
 Number of entries: 4 – cable glands.  
 Inside dimensions: 89x89x41 mm  
 Dimensions: 92x92x50 mm

